

# ZEISS

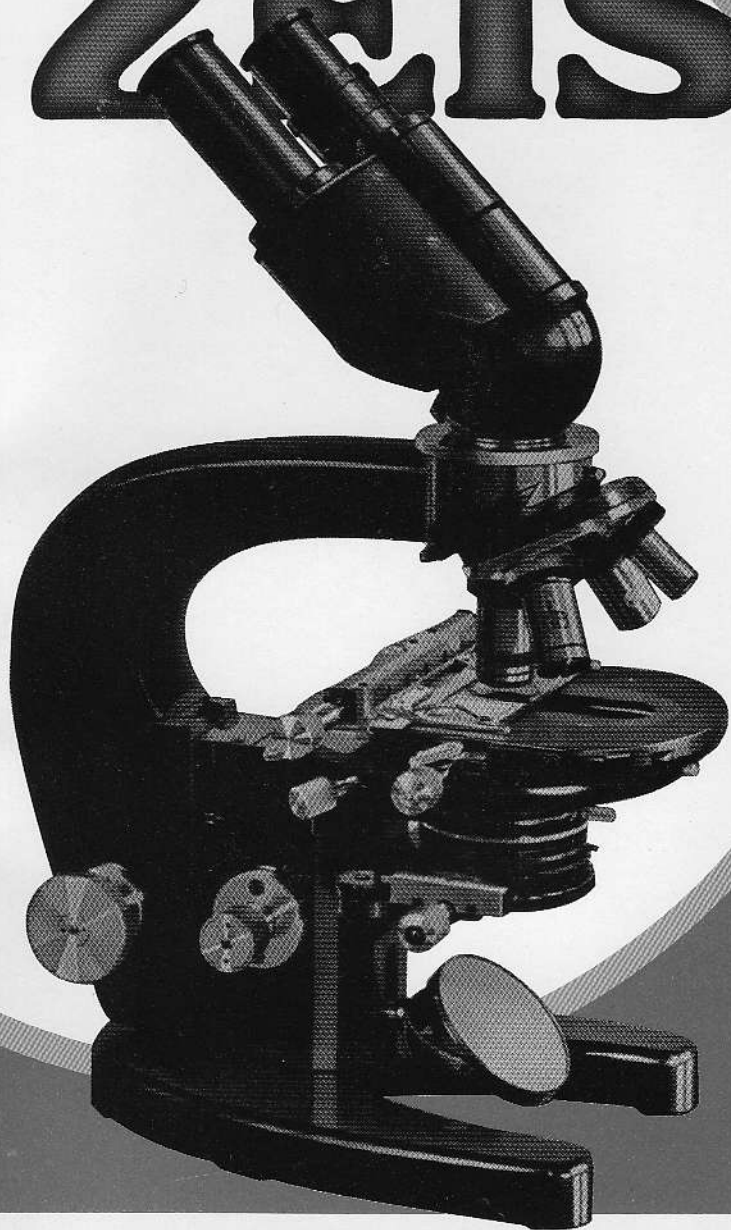

CARL ZEISS  
JENA

Mikro 423/V e.

Scientific journals desiring to use illustrations appearing in this catalogue will be gladly furnished with full size electros, or with reductions of these if available.

All rights reserved.

Illustrations not to be considered binding as to details of design.

This reprint of the Carl Zeiss 1937 Microscope catalogue is presented by The Zeiss Historica Society of America in conjunction with our stated objective to study and exchange information on the significant products and innovations of that firm.

Address inquiries to: The Zeiss Historica Society,  
300 Waxwing Drive, Cranbury, NJ 08512, U.S.A.

© Zeiss Historica Society 1990. All rights reserved under Pan American and Universal Copyright Conventions by Zeiss Historica Society. Reproduction without permission is prohibited.

Printed by Seaboard Printing Limited, 1140 Bedford Highway, Bedford, Nova Scotia, Canada, B4A 1B8

# ZEISS MICROSCOPES

This catalogue is intended to give a brief survey of microscopes and their more immediate equipment as at present manufactured by us. In addition, to stands of traditional type and time-proved efficiency, we are now able to offer a range of entirely new models, which are the outcome of many years of development in design and trial in practice.

Entirely new avenues have been explored with the object of still further enhancing the standard of performance of microscopes, of rendering them as far as possible independent of the shape of the objects to be examined, and of securing the maximum of convenience in use.

Wherever we have thus far been able to show them, our new designs have met with general interest and appreciation. This encourages us in the belief that we are holding the right course in our endeavour to lead in optical design and manufacture and to justify our slogan "Zeiss, Quality, Progress".

## CARL ZEISS JENA

Jena, October 1937



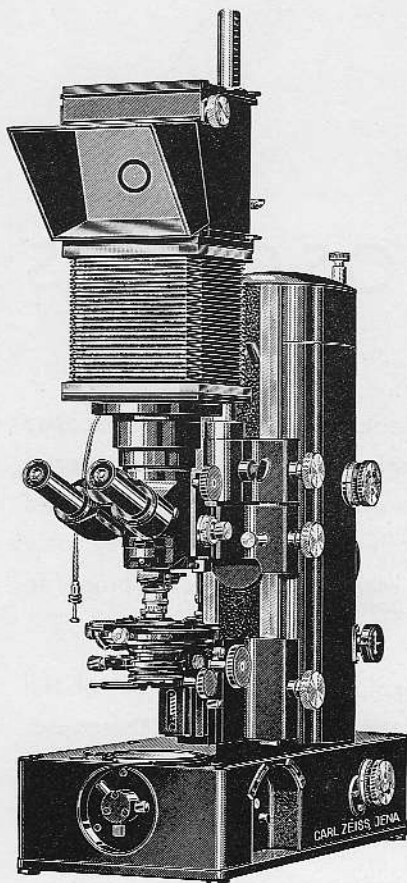

## **"Ultraphot"**

**New high  
performance  
microscope  
with camera**

Fig. 1  
about  $\frac{1}{9}$  actual size

25088

The Ultraphot is a universal instrument for all kinds of microscopy and low-power survey work, for metallography, and for photo-micrography and cine-micrography.

It is available with a number of different components, and we quote the following as a specimen outfit.

### **Complete Ultraphot outfit**

for monocular examination and photo-micrography in ordinary transmitted light, giving magnifications between  $50\times$  and  $1200\times$ , including achromatic objectives 10/0.30, 20/0.40, 40/0.65, and immersion objective 90/1.25, as well as  $6\times$ ,  $9\times$ ,  $12\times$  photographic eyepieces, and  $7\times$  and  $15\times$  Huygens eyepieces.

Codeword: *Kligy*

Key number 1



For detailed description, see "Mikro 527 e"

# Large Universal Microscope for research purposes

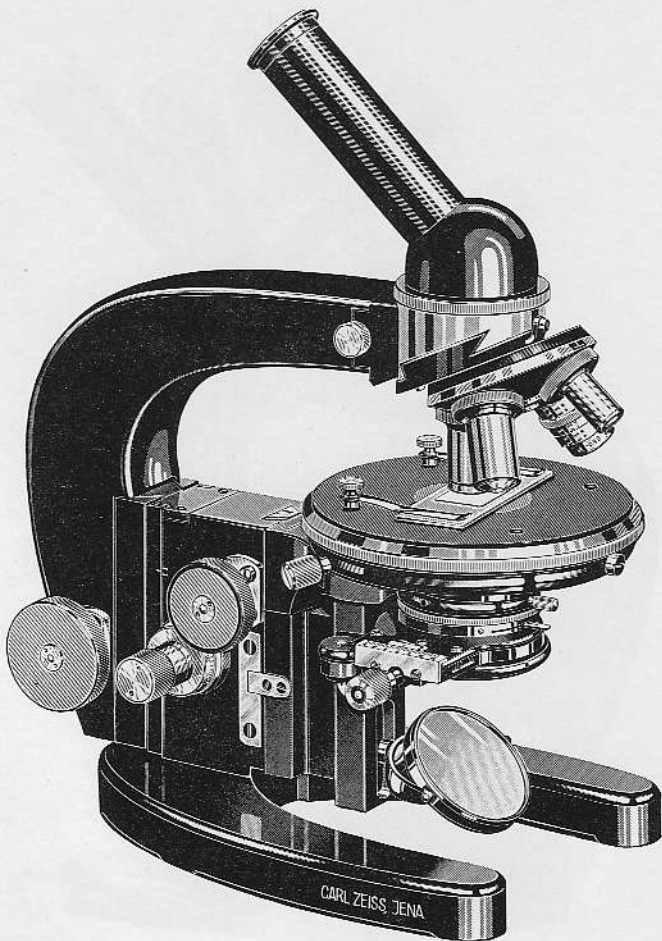

Fig. 2  
about  $\frac{2}{3}$  actual size

23665

**Stand LuWdD**, with low placed coarse and slow motion heads, interchangeable tube carrier with inclined monocular tube, interchangeable stage carrier with vulcanite stage D and rotating and centring movements as well as height adjustment, and interchangeable pinion box with mirror and Abbe illuminating apparatus Wd, in mahogany case with lock and key

Key number		Key number 2
3	Aplanatic condenser N. A. 1.4 . . . . .	Apochromatic objective 90, N. A. 1.3, oil-immersion . . . . . 8
4	Quadruple revolving nose-piece, on slide	
5	Apochromatic objective 10, N. A. 0.30	
6	Apochromatic objective 20, N. A. 0.65	Compensating eyepiece, 5 $\times$ . . . . . 9
	Apochromatic objective 60, N. A. 1.0, homogeneous oil immersion type with iris diaphragm. (for dark ground illumination) . . . . .	Compensating eyepiece, 7 $\times$ . . . . . 10
7		Compensating eyepiece, 10 $\times$ . . . . . 11
		Compensating eyepiece, 15 $\times$ . . . . . 12
<b>Magnifications: 50<math>\times</math> to 1350<math>\times</math></b>		<b>Codeword: <i>Kiwtu</i></b> <u>13</u>

The above microscope with large mechanical stage E, (see illustration), instead of stage type D  
Accessories:

**Binocular inclined eyepiece tube, Bitukni L**, (see front cover) with clamp, 1.5 $\times$  magnification  
Codeword: *Kneeb* 15

Additional compensating eyepieces for the Bitukni L eyepiece tube 5 $\times$ , 7 $\times$ , or 10 $\times$  magnification  
Codeword: *Kiwyz* 16

Further objectives and eyepieces will be found in the list at the end of this catalogue



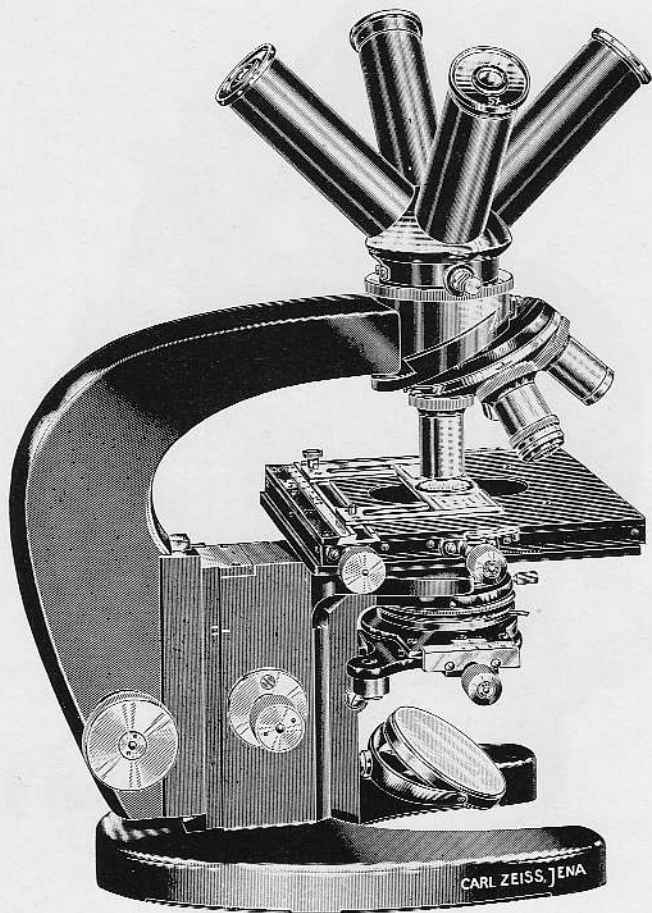

## Modern Research Microscope

with quadruple  
eyepiece revolver

Fig. 3  
about  $\frac{2}{3}$  actual size

22284

**Stand LWdG**, with low placed coarse and slow motion heads, quadruple eyepiece revolver, rectangular mechanical stage G (range  $75 \times 50$  mm.), and Abbe illuminating apparatus Wd, in mahogany case with lock and key

Key number 17

	Key number		
Aplanatic condenser, N. A. 1.4 . . . . .	18	Apochromatic objective 90, N. A. 1.30,	
Quadruple revolving nosepiece on slide	19	homogeneous oil immersion . . . . .	23
Apochromatic objective 10, N. A. 0.30 .	20	Compensating eyepiece, $5 \times$ . . . . .	24
Apochromatic objective 20, N. A. 0.65 .	21	Compensating eyepiece, $7 \times$ . . . . .	25
Apochromatic objective 60, N. A. 1.0,		Compensating eyepiece, $10 \times$ . . . . .	26
homogeneous oil immersion with iris		Compensating eyepiece, $15 \times$ . . . . .	27
diaphragm (for dark ground observa- tion) . . . . .	22		

Magnifications:  $50 \times$  to  $1350 \times$

Codeword: *Klihz* 28

For detailed description, see "Mikro 492 e"

Further objectives and eyepieces will be found in the list at the end of this catalogue



# Large Routine Microscope

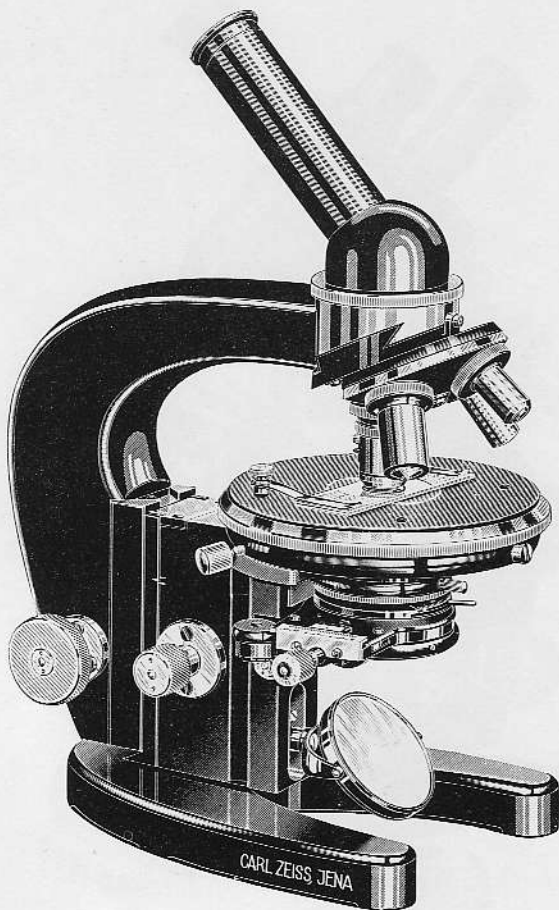

Fig. 4  
about  $\frac{2}{5}$  actual size

25007

**Stand LWdD**, with low placed coarse and slow motion heads, inclined monocular eyepiece tube, rotating and centring stage D of vulcanite and Abbe illuminating apparatus Wd, in mahogany case with lock and key

Key number 29

Condenser, N. A. 1.2 . . . . .	Key number 30	Achromatic oil immersion objective 90, N. A. 1.25, with iris diaphragm (also for dark ground observation) . . . . .	35
Quadruple revolving nosepiece on slide . . . . .	31	Huygens eyepiece, 7 $\times$ . . . . .	36
Achromatic objective 8, N. A. 0.20 . . . . .	32	Huygens eyepiece, 10 $\times$ . . . . .	37
Achromatic objective 20, N. A. 0.40 . . . . .	33	Compensating eyepiece 15 $\times$ . . . . .	38
Achromatic objective 40, N. A. 0.65 . . . . .	34		
Magnifications: 56 $\times$ to 1350 $\times$		Codeword: <i>Kliia</i>	<u>39</u>

Above microscope with large mechanical stage E, (range 75 $\times$  50 mm., see cover illustration), instead of vulcanite stage D. Codeword: *Klild* 40

Supplementary equipment:

"Bitukni L" inclined binocular tube (see cover illustration), with clamp, magnification 1.5 $\times$  . . . . . Codeword: *Kmceb* 41

For use with "Bitukni L": Huygens eyepieces, 7 $\times$  and 10 $\times$  . . . . . Codeword: *Kaoee* 42

For detailed description, see "Mikro 492 e"

Further objectives and eyepieces will be found in the list at the end of this catalogue



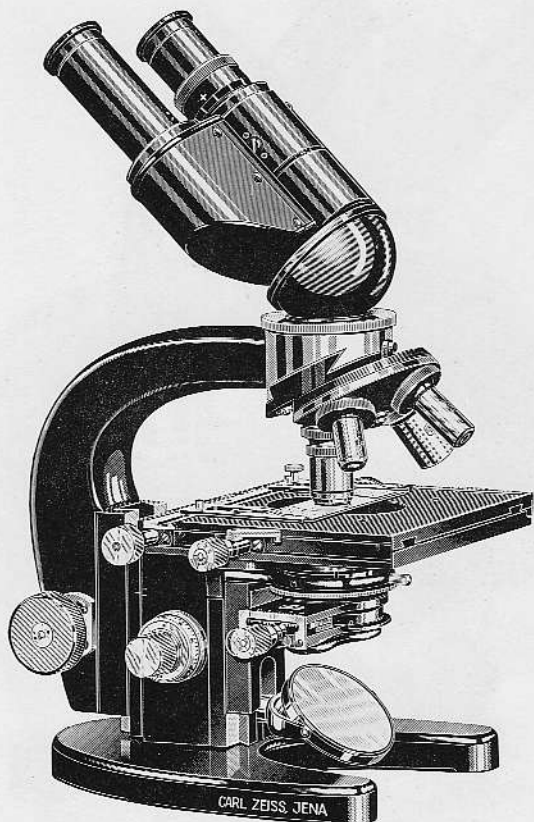

## Medium Binocular Routine Microscope

for diagnostic  
purposes

Fig. 5  
about  $\frac{2}{3}$  actual size

25006

**Stand LgOdG**, with low placed coarse and slow motion heads, Bitukni L inclined binocular eyepiece tube with clamp, O substage with rack and pinion adjustment, and rectangular mechanical stage G (range  $75 \times 50$  mm.), in locked case . . . . . Key number 43

Condenser N. A. 1.2 with revolving and decentering iris diaphragm and filter glass holder . . . . .	44
Quadruple nosepiece on slide . . . . .	45
Achromatic objective 8, N. A. 0.20 . . . . .	46
Achromatic objective 40, N. A. 0.65 . . . . .	47

Achromatic oil immersion objective 90, N. A. 1.25, with iris diaphragm (also suitable for dark-ground illumination) . . . . .	48
Paired Huygens eyepieces $5 \times$ . . . . .	49
Paired Huygens eyepieces $10 \times$ . . . . .	50

Magnifications:  $60 \times$  to  $1350 \times$

Codeword: *Klime* 51

The above microscope, but with simplified mechanical stage A, (see fig. 6) instead of stage G . . . . . Codeword: *Klinf* 52

Accessories:

Inclined monocular eyepiece tube L . . Codeword: *Kalos* 53

Huygens eyepiece for same,  $15 \times$  . . Codeword: *Migliarol* 54

Further objectives and eyepieces will be found in the list at the end of this catalogue





# Medium Monocular Routine Microscope

for diagnostic  
purposes

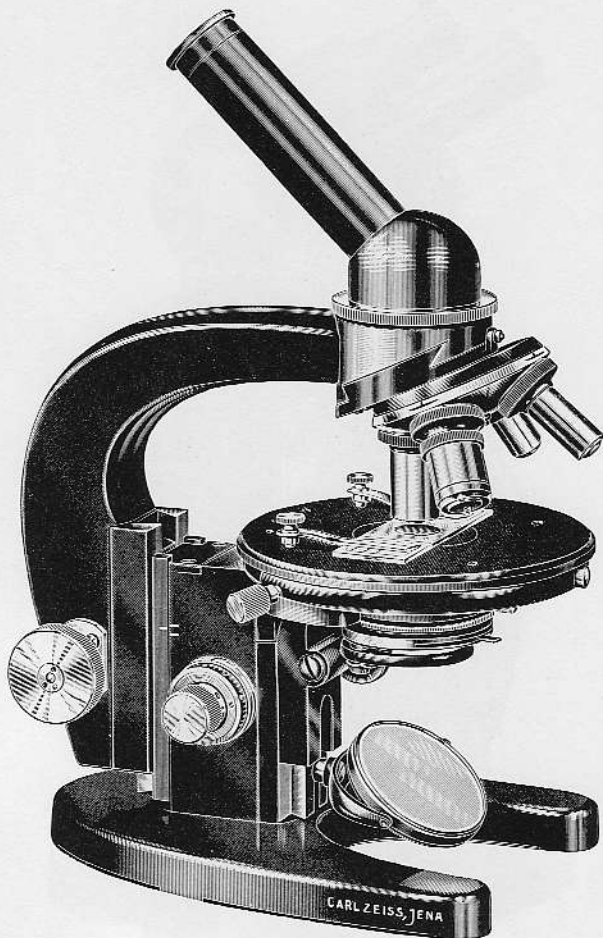

Fig. 6  
about  $\frac{2}{3}$  actual size

23074

**Stand Lg OA**, with low placed coarse and slow motion heads, inclined monocular eyepiece tube, O substage with rack and pinion adjustment, simple mechanical stage A, in locked case . . . . . Key number 55

Key number		Key number	
Condenser N. A. 1.2 with iris diaphragm and filter glass holder . . . . .	56	Achromatic oil immersion objective 90, N. A. 1.25 with iris diaphragm (also suitable for dark-ground illumination) . . . . .	60
Quadruple nosepiece on slide . . . . .	57	Huygens eyepiece 5 $\times$ . . . . .	61
Achromatic objective 8, N. A. 0.20 . . . . .	58	Huygens eyepiece 10 $\times$ . . . . .	62
Achromatic objective 40, N. A. 0.65 . . . . .	59	Huygens eyepiece 15 $\times$ . . . . .	63
Magnifications: 40 $\times$ to 1350 $\times$		Codeword: <i>Kirua</i> <u>        </u> 64	

The above microscope, but with rectangular mechanical stage G, range 75 $\times$ 50 mm., instead of stage A . . . . . Codeword: *Kisaf* 65

Accessories:

Bitukni L inclined binocular eyepiece tube (see fig. 5) with clamp, 1.5 $\times$ magnification . . . . .	Codeword: <i>Kmeeb</i>	66
Additional compensating eyepiece for the Bitukni L, Huygens type, 5 $\times$ or 10 $\times$ . . . . .	Codeword: <i>Kisdi</i>	67

Further objectives and eyepieces will be found in the list at the end of this catalogue



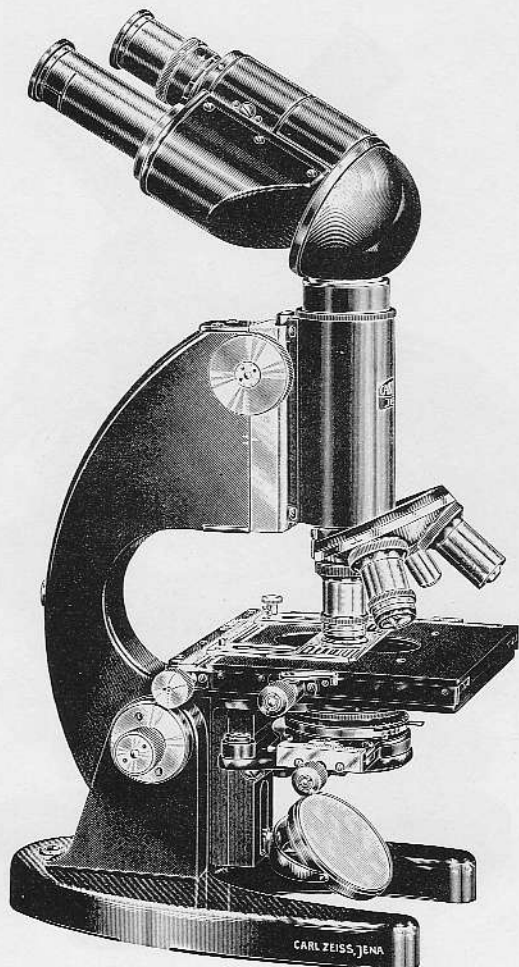

## Binocular Routine and Research Microscope

with inclined eyepieces

Fig. 7  
about  $\frac{2}{3}$  actual size

22403

**Stand UCG**, with slow motion head in tilting axis, inclinable through  $90^\circ$ , "Bitukni" inclined binocular tube with focusing correction, interchangeable with straight eyepiece tube, Abbe illuminating apparatus C and rectangular mechanical stage G (range  $75 \times 50$  mm.), in oak case with lock and key

Key number 68

	Key number		
Condenser, N. A. 1.2 . . . . .	69	Fluorite objective 100, N. A. 1.30,	
Quadruple revolving nosepiece . . . . .	70	homogeneous oil immersion . . . . .	74
Achromatic objective 10, N. A. 0.30 . . . . .	71	Paired Huygens eyepieces, $7\times$ . . . . .	75
Achromatic objective 20, N. A. 0.40 . . . . .	72	Paired Huygens eyepieces, $10\times$ . . . . .	76
Fluorite objective 40, N. A. 0.85, with		Paired compensating eyepieces, $15\times$ . . . . .	77
correction mount . . . . .	73		

Magnifications:  $70\times$  to  $1500\times$

Codeword: *Katup* 78

For detailed description, see "Mikro 497 e"



Further objectives and eyepieces will be found in the list at the end of this catalogue

# Monocular Routine Microscope

with inclined eyepiece

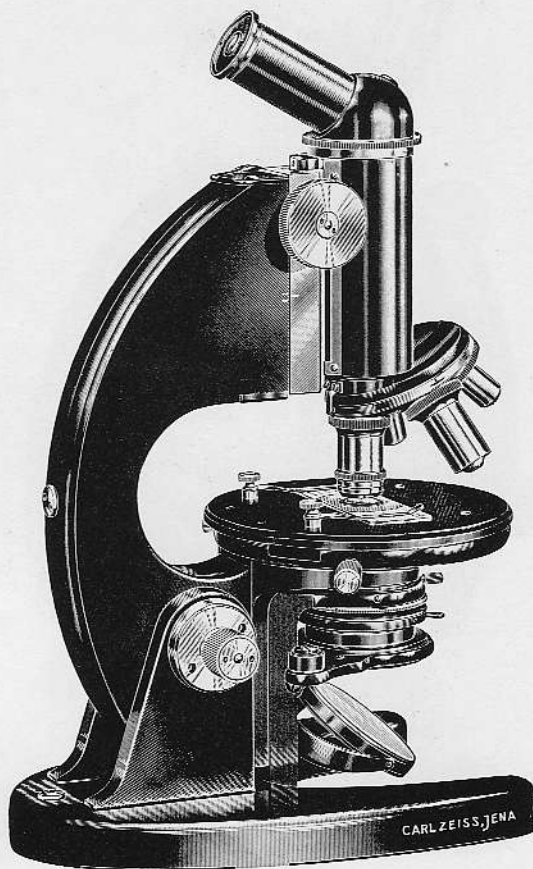

Fig. 8  
about  $\frac{2}{3}$  actual size

22429

**Stand UTA**, with slow motion head in tilting axis, inclinable through 90°, inclined eyepiece tube, interchangeable with straight draw tube with millimetre scale, substage T with swing-out iris diaphragm and simplified mechanical stage A, in oak case with lock and key . . . Key number 79

Key number			
Condenser, N. A. 1.2 . . . . .	80	Achromatic oil immersion objective 90, N. A. 1.25, with iris diaphragm (also for dark ground observation) . . . . .	84
Quadruple revolving nosepiece . . . . .	81	Huygens eyepiece, 7× . . . . .	85
Achromatic objective 8, N. A. 0.20 . . . . .	82	Huygens eyepiece, 15× . . . . .	86
Achromatic objective 40, N. A. 0.65 . . . . .	83	Codeword: <i>Katyu</i>	<u>87</u>

Magnifications: 56× to 1350×

Above microscope, but with straight eyepiece tube only . . . . . Codeword: *Kauez* 88

Supplementary:

**Quadruple eyepiece revolver** (without eyepieces), see fig. 27 . . . . . Codeword: *Khegy* 89

For detailed description, see "Mikro 497 e"

Further objectives and eyepieces will be found in the list at the end of this catalogue



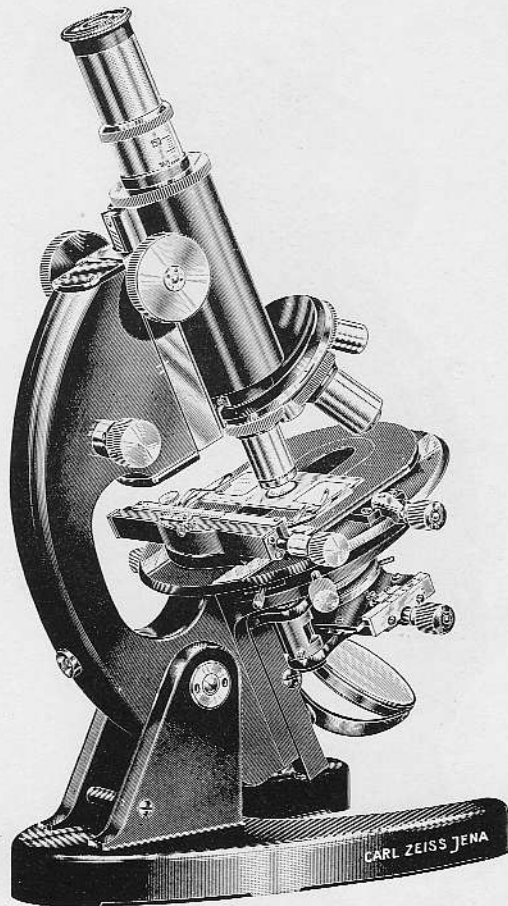

## Medium Routine and Research Microscope

Fig. 9  
about  $\frac{2}{5}$  actual size

13698

**Stand EOdE**, inclinable through  $90^\circ$ , draw tube with millimetre divisions, substage O with rack and pinion adjustment, large mechanical stage E (range  $75 \times 50$  mm.), in locked case . . . . . Key number 90

	Key number		
Condenser, N. A. 1.2 with revolving and decentring iris diaphragm and coloured glass holder . . . . .	91	Fluorite objective 100, N. A. 1.30, homogeneous oil immersion . . . . .	96
Quadruple revolving nosepiece . . . . .	92	Huygens eyepiece, $5\times$ . . . . .	97
Achromatic objective 3 . . . . .	93	Huygens eyepiece, $7\times$ with micrometer . . . . .	98
Achromatic objective, 8, N. A. 0.20 . . . . .	94	Huygens eyepiece, $10\times$ . . . . .	99
Achromatic objective 40, N. A. 0.65 . . . . .	95	Compensating eyepiece, $15\times$ . . . . .	100
		Stage micrometer, 1:100 . . . . .	101

Magnifications:  $15\times$  to  $1500\times$

Codeword: *Kliog* 102

Above microscope, with revolving and centring vulcanite stage D instead of large mechanical stage E . . . . . Codeword: *Kliph* 103

For detailed description, see "Mikro 405 e"



Further objectives and eyepieces will be found in the list at the end of this catalogue

# Medium Routine Microscope

designed especially for  
the examination of  
blood and similar  
purposes

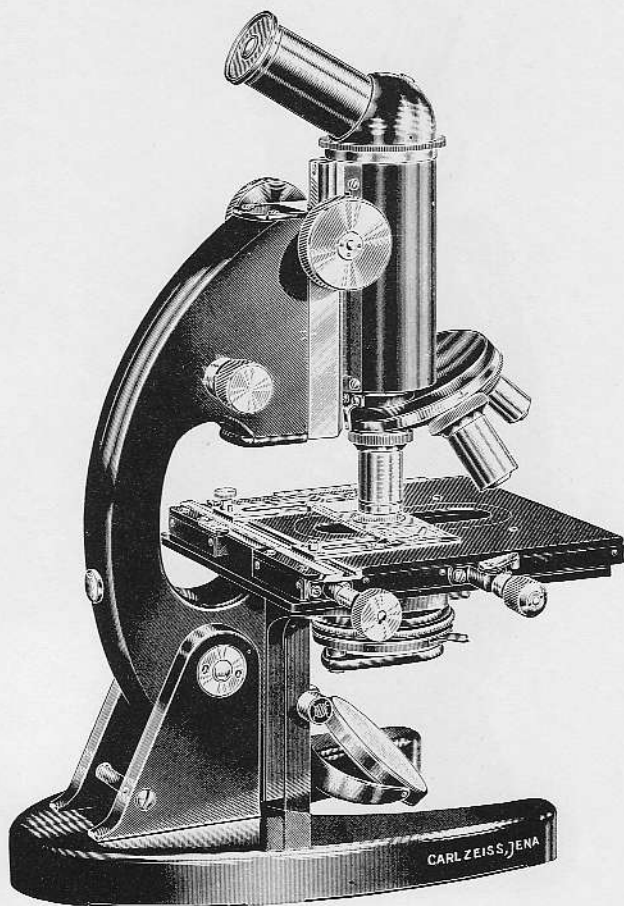

Fig. 10  
about  $\frac{2}{5}$  actual size

22430

Stand EOG, inclinable through  $90^\circ$ , inclined eyepiece tube, interchangeable with vertical eyepiece tube, substage O with rack and pinion adjustment, and rectangular mechanical stage G (range  $75 \times 50$  mm.), in locked case

Key number 104

Condenser, N. A. 1.2, with iris diaphragm and coloured glass holder . . . . .	105	Apochromatic objective 60, N. A. 1.0, with iris diaphragm (especially intended for dark ground observation) . . . . .	110
Quadruple revolving nosepiece . . . . .	106	Compensating eyepiece, $5 \times$ . . . . .	111
Apochromatic objective 10, N. A. 0.30 . . . . .	107	Compensating eyepiece, $10 \times$ . . . . .	112
Apochromatic objective 20, N. A. 0.65 . . . . .	108	Compensating eyepiece, $15 \times$ . . . . .	113
Apochromatic objective 90, N. A. 1.30, homogeneous oil immersion . . . . .	109		

Magnifications:  $50 \times$  to  $1350 \times$

Codeword: *Kliul* 114

Supplementary for Stand E:

Quadruple eyepiece revolver (without eyepieces), see fig. 27

Codeword: *Khegy* 115

For detailed description, see "Mikro 405 e"

Further objectives and eyepieces will be found in the list at the end of this catalogue



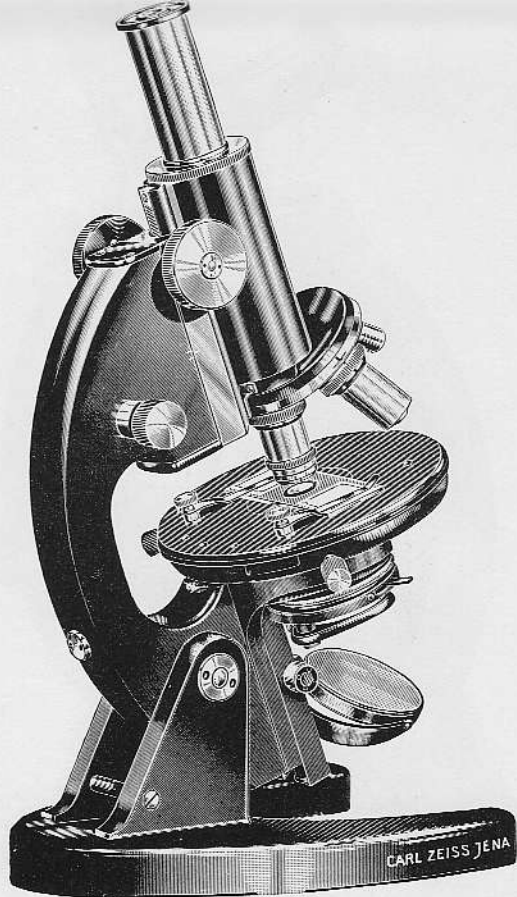

## Medium Routine Diagnostic Microscope

Fig. 11  
about  $\frac{2}{3}$  actual size

13701

**Stand EOA, inclinable through 90°, fixed eyepiece tube, substage O with rack and pinion adjustment, simple mechanical stage A, in locked case**

Key number **116**

	Key number		
Condenser, N. A. 1.2 with iris diaphragm . . . . .	117	Achromatic oil immersion objective 90, N. A. 1.25, with iris diaphragm (also for dark ground observation) . . . . .	121
Quadruple revolving nosepiece . . . . .	118	Huygens eyepiece, 7× . . . . .	122
Achromatic objective 8, N. A. 0.20 . . . . .	119	Huygens eyepiece, 15× . . . . .	123
Achromatic objective 40, N. A. 0.65 . . . . .	120		

Magnifications: 56× to 1350×

Codeword: *Kliri* 124

Supplementary equipment:

**"Monokni E" inclined monocular tube, in plain case . . . . .** Codeword: *Kanef* 125

**"Bitukni I" inclined binocular tube, in plain case . . . . .** Codeword: *Kacer* 126

**Additional eyepieces for "Bitukni", H 7× and H 15× . . . . .** Codeword: *Kaorr* 127

For detailed description, see "Mikro 405 e"

Further objectives and eyepieces will be found in the list at the end of this catalogue



# Class Microscope

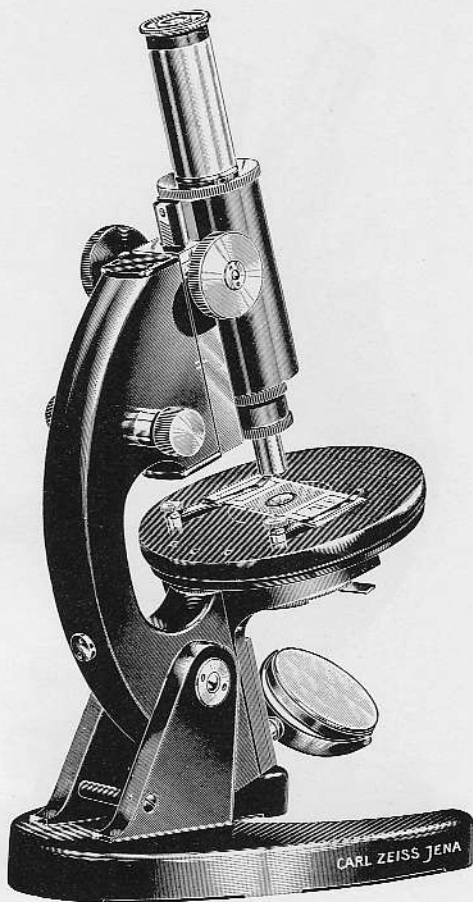

Fig. 12  
about  $\frac{2}{5}$  actual size

13703

**Stand EB, inclinable through  $90^{\circ}$ , with non-extensible tube and fixed circular stage with fixed condenser sliding sleeve, in case with lock and key**

Key number 128

	Key number		
Iris cylinder diaphragm . . . . .	129	Huygens eyepiece, $7\times$ . . . . .	132
Achromatic objective 8, N. A. 0.20 . . . . .	130	Huygens eyepiece, $15\times$ . . . . .	133
Achromatic objective 40, N. A. 0.65 . . . . .	131		
Magnifications: $56\times$ to $600\times$		Codeword: <i>Kaoss</i>	<u>134</u>

Above microscope with fixed **rectangular** stage instead of circular stage

Codeword: *Kaott* 135

For detailed description, see "Mikro 405 e"

Further objectives and eyepieces will be found in the list at the end of this catalogue



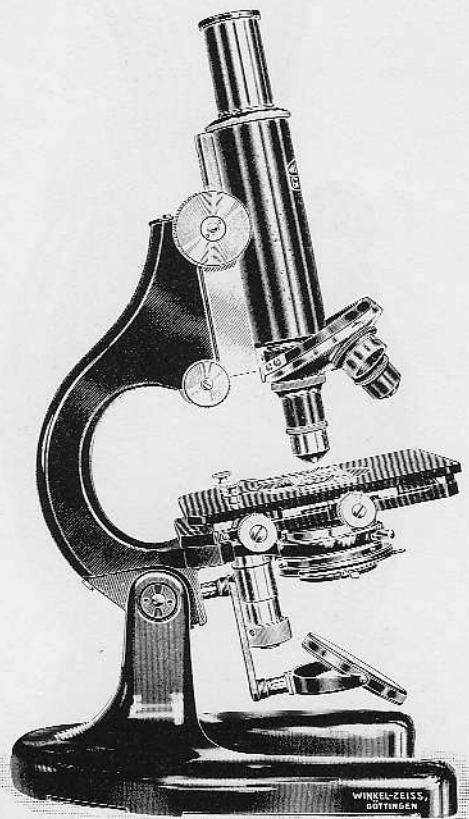

## Winkel-Zeiss Microscope\*)

for diagnosis

Fig. 13  
about  $\frac{2}{5}$  actual size

**Winkel-Zeiss Stand RSK**, inclinable through 90°. Fixed eyepiece tube, swing-out substage S with side screw to raise or lower the condenser, and rectangular mechanical stage K (25 mm travel) in locked case

Key number 136

Key number		
Condenser N. A. 1.2 with iris diaphragm and filter glass holder . . . . .	137	Achromatic objective 90, N. A. 1.30, homogeneous oil immersion . . . . . 141
Triple nosepiece . . . . .	138	Huygens eyepiece 6 $\times$ . . . . . 142
Achromatic objective 10, N. A. 0.78 . . . . .	139	Huygens eyepiece 12 $\times$ . . . . . 143
Achromatic objective 42, N. A. 0.85 . . . . .	140	

Magnifications: 60 to 1080 $\times$

Codeword: *Wofer* 144

The above microscope, but with simple circular mechanical stage A instead of stage K . . . . . Codeword: *Woffs* 145

For detailed description, see "Winkel No. 242"

\*) Winkel-Zeiss stands can also be supplied with Zeiss optics.

Further objectives and eyepieces will be found in the list at the end of this catalogue





# Winkel-Zeiss Microscope

for biological and  
medical purposes

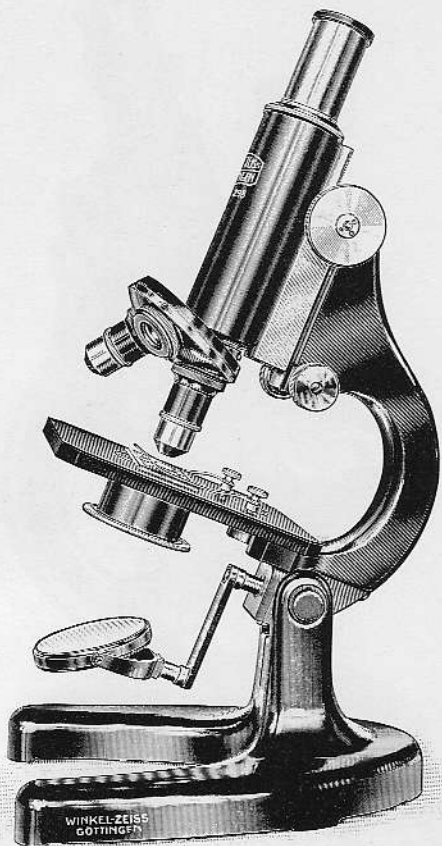

Fig. 14  
about  $\frac{2}{3}$  actual size

**Winkel-Zeiss Stand RBC**, inclinable through  $90^\circ$ , with non-extensible tube, fixed rectangular stage, fixed condenser sliding sleeve and cylinder diaphragm with three stops, in alder case with lock and key Key number 146

	Key number		
Double revolving nosepiece . . . . .	147	Huygens eyepiece, $6\times$ . . . . .	150
Achromatic objective 12.6, N. A. 0.30 . . . . .	148	Huygens eyepiece, $12\times$ . . . . .	151
Achromatic objective 42, N. A. 0.85 . . . . .	149		
Magnifications: 75 to $504\times$		Codeword: <i>Wodpe</i>	<u>152</u>
Above Microscope with fixed circular stage (in place of the rectangular stage) . . . . .		Codeword: <i>Wodui</i>	153
Supplementary:			
Condenser N. A. 1.2 with Iris diaphragm		Codeword: <i>Wincepit</i>	<u>154</u>

For detailed description, see "Winkel No. 444"

Further objectives and eyepieces will be found in the list at the end of this catalogue





## Winkel-Zeiss Microscope

for instruction and  
practice

Fig. 15  
about  $\frac{2}{3}$  actual size

**Winkel-Zeiss Stand JBR**, inclinable through  $90^\circ$ , with non-extensible tube, fixed circular stage, fixed condenser sliding sleeve and cylinder diaphragm with three stops, in alder case with lock and key Key number 155

	Key number		
Achromatic objective 10, N. A. 0.28 . . . . .	156	Huygens eyepiece, $6\times$ . . . . .	158
Achromatic objective 42, N. A. 0.85 . . . . .	157	Huygens eyepiece, $12\times$ . . . . .	159
Magnifications: 60 to $504\times$		Codeword: <i>Woavm</i>	<u>160</u>
Above Microscope with fixed rectangular stage (in place of the circular stage) . . . . .		Codeword: <i>Woaog</i>	161
Supplementary:			
Triple revolving nosepiece . . . . .		Codeword: <i>Woaph</i>	162

For detailed description, see "Winkel No. 443"

Further objectives and eyepieces will be found in the list at the end of this catalogue



# Binocular Magnifier Stand XII

with large field of  
view

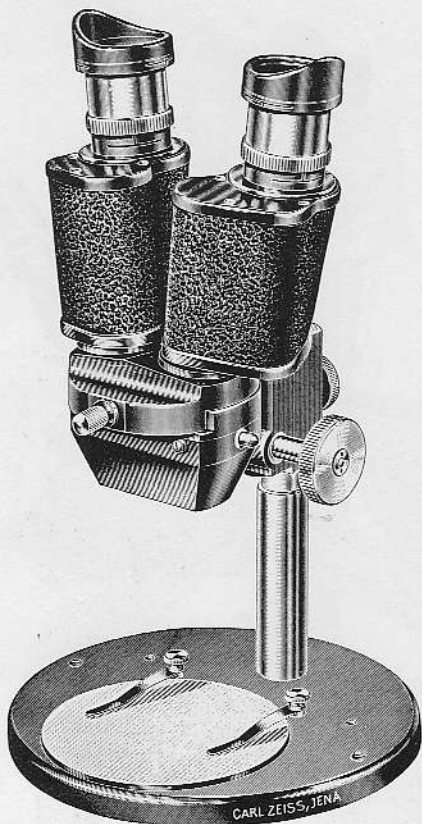

Fig. 16  
about  $\frac{1}{3}$  actual size

22446

**Stand XII A:** Double tube (prism body) with rack and pinion motion, column on circular base with stage disc, in case . . . . . Key number 163

	Key number		Key number
Paired objectives $1\frac{1}{2}\times$	164	Paired eyepieces, $8\times$	167
Paired objectives $1\frac{1}{4}\times$	165	Paired eyepieces, $12\frac{1}{2}\times$	168
Paired objectives $2\frac{1}{2}\times$	166		

Magnifications: 4 to  $31\times$

Codeword: *Kaozz* 169

In addition to the stand shown in the above illustration, we carry a number of other stands for Magnifier XII enabling it to be used as a routine instrument in every branch of industry and science.

For detailed description, see "Mikro 464 e"



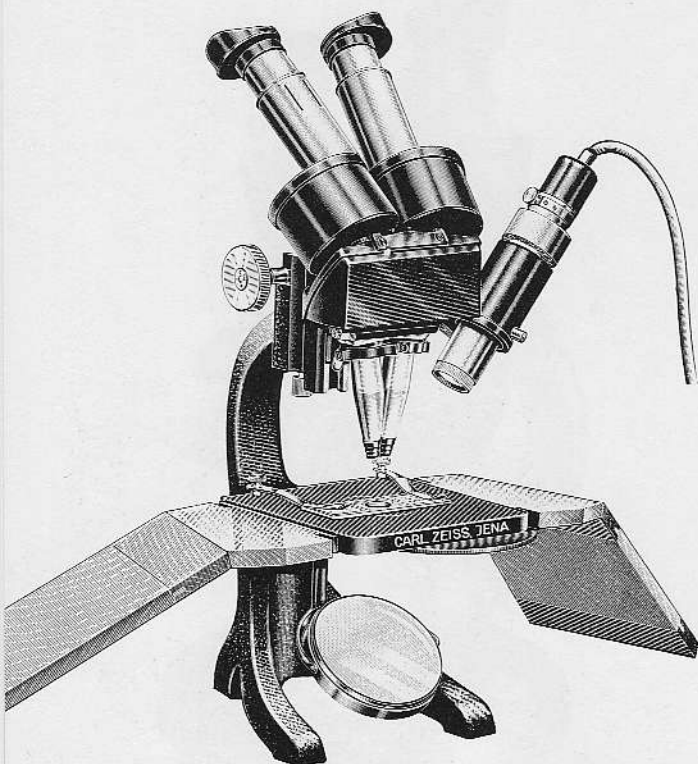

## Stereoscopic Dissecting Microscope Stand X

with inclined eyepieces

Fig. 17  
about  $\frac{2}{3}$  actual size

23259

**Stand XA** with binocular erecting eyepiece, inclined eyepiece tubes, rack and pinion focusing, fixed stage with arm-rests, and large flat and concave mirrors, in locked case . . . . . Key number **170**

		Key number		
Pair of objectives 2	171	Paired eyepieces 8 $\times$	173	
Pair of objectives 4	172	Paired eyepieces 12 $\times$	174	

Magnifications: 18 to 53 $\times$

Codeword: *Kmaza* 175

The above microscope, but with vertical eyepiece tube instead of inclined tube and with Pairs of Huygens eyepieces 4 $\times$  and 7 $\times$  (magnifications: 8 $\times$  to 28 $\times$ ). . . . . Codeword: *Kaogy* **176**

For the preparation and examination of objects that are too large to go comfortably on stand XA, the two larger stands XB and XC are available. Further details regarding these and other binocular instruments, together with lists of objectives and eyepieces for binocular paired work are given in list Mikro 375.

For simple dissecting microscope, see list "Winkel No. 222"

Illuminators for the above instruments are shown in Mikro 375



# Stereoscopic Dissecting Microscope Stand XV

with inclined eyepieces  
and extended field of  
view

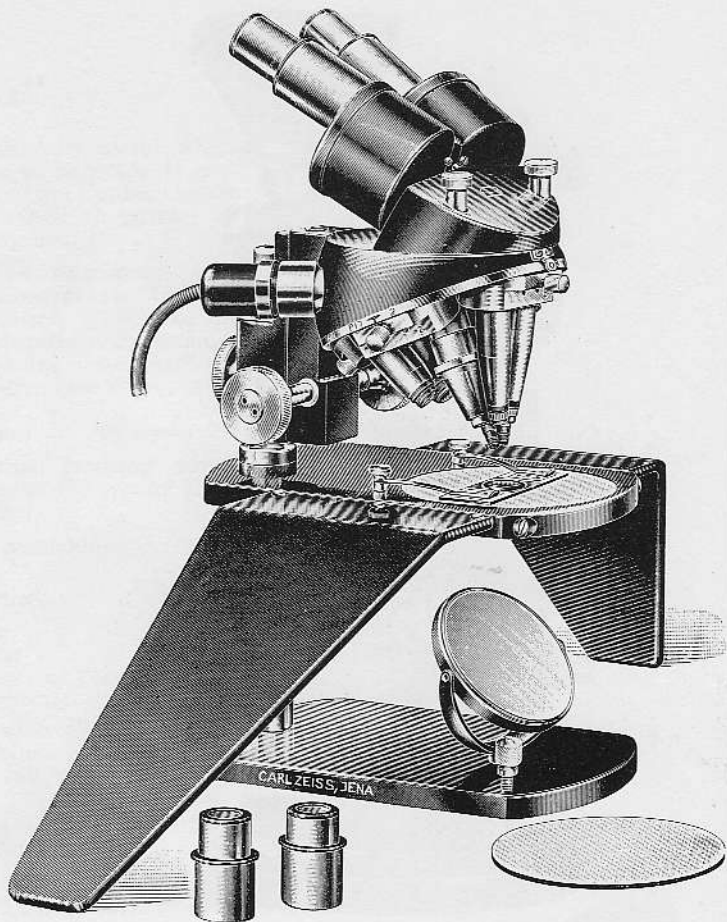

Fig. 18  
about  $\frac{2}{5}$  actual size

22806

**Stand XV**, consisting of inclined double tube on quadruple nosepiece with built-in illuminating device for incident light with rack and pinion focusing motion on column stand with mirror and rectangular stage, including 1 each metal and glass drop-in stage plates, two arm rests and three frosted bulbs, in alder case . . . Codeword: *Kfinz* Key number 177

	Paired objectives					Paired eyepieces			
Notation .	2×	4×	8×	12×	7×=Pl	6×	8×	12×	18×
Key number	178	179	180	181	182	183	184	185	186
Codeword .	<i>Kfioa</i>	<i>Kfite</i>	<i>Kfiuf</i>	<i>Kfixi</i>	<i>Kfoaf</i>	<i>Kiolu</i>	<i>Kfoch</i>	<i>Kfodi</i>	<i>Kfoej</i>

1 Paired eyecup for spectacle wearers . . . . . Codeword: *Kiopy* 187

Electrical accessories for connecting the illumination system to the mains:

a) for alternating current

Codeword

- |                                                                         |              |     |
|-------------------------------------------------------------------------|--------------|-----|
| 1. Fixed transformer with connecting cable for 110 volts . . . . .      | <i>Kfojn</i> | 188 |
| for 220 volts . . . . .                                                 | <i>Kfojo</i> | 189 |
| 2. Adjustable transformer with scale and connecting cable for 110 volts | <i>Kfont</i> | 190 |
| for 220 volts                                                           | <i>Kfoty</i> | 191 |

b) for direct current

- |                                                                          |              |     |
|--------------------------------------------------------------------------|--------------|-----|
| Regulating resistance with connecting cable for 110 volts . . . . .      | <i>Kfouz</i> | 192 |
| for 220 volts . . . . .                                                  | <i>Kfova</i> | 193 |
| Spare bulb 8 volts 0.6 amp. half-frosted (with centred socket) . . . . . | <i>Pepca</i> | 194 |

For detailed description, see "Mikro 510"



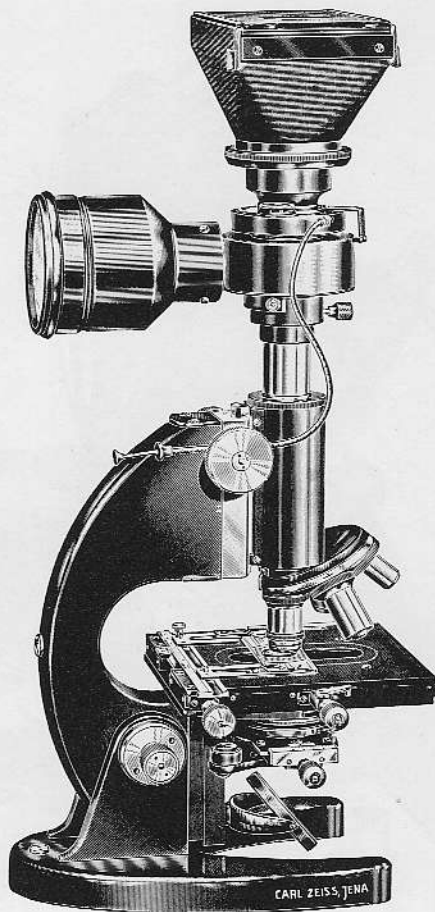

## Universal Camera Attachment "Miflex"

Can be used with any  
available Microscope

Fig. 19  
about  $\frac{1}{4}$  actual size

Miflex Camera on Stand UCG

22607

Universal Miflex camera attachment and focusing screen, including Klio shutter, special flexible release, and two dark slides, in box: Codeword <sup>Key</sup> number

- |                                                                                                            |              |     |
|------------------------------------------------------------------------------------------------------------|--------------|-----|
| 1. with camera taking $6\frac{1}{2} \times 9$ cm ( $3\frac{1}{2} \times 2\frac{1}{2}$ " ) plates . . . . . | <i>Kepch</i> | 195 |
| The same, but with optical focusing device instead of ground-glass screen . . . . .                        | <i>Kitko</i> | 196 |
| 2. with camera taking $9 \times 12$ cm ( $4\frac{3}{4} \times 3\frac{1}{2}$ " ) plates . . . . .           | <i>Kiaax</i> | 197 |
| The same, but with optical focusing device instead of ground-glass screen . . . . .                        | <i>Klcto</i> | 198 |

**Accessories:**

- |                                                                                       |                  |     |
|---------------------------------------------------------------------------------------|------------------|-----|
| Focusing magnifier, $6 \times$ (not achromatic) . . . . .                             | <i>Militerom</i> | 199 |
| Clear glass screen, in push-on mount . . . . .                                        | <i>Kepfi</i>     | 200 |
| Clear glass screen, with clamping device and adjustable aplanatic magnifier . . . . . | <i>Kijgu</i>     | 201 |
| Dark slide, $6\frac{1}{2} \times 9$ cm plates . . . . .                               | <i>Kepil</i>     | 202 |
| Dark slide $9 \times 12$ cm plates . . . . .                                          | <i>Miolei</i>    | 203 |
| Smoked glass, in mount for eyepiece . . . . .                                         | <i>Keplo</i>     | 204 |

The Miflex may be used with a considerable number of eyepieces, and is very suitable for survey work at low powers in conjunction with the Winkel-Zeiss Luminar stand.

For detailed description, see "Mikro 502"



## "Contax-Miflex"

This instrument is particularly useful where series of exposures have to be made. It may be used with all models of the Contax camera (made by Zeiss Ikon), though an adapter for each camera model is required.

**Universal Miflex camera attachment with distance piece for attachment to "Contax" camera** (optical magnification  $\frac{1}{2}\times$ ) including Klio shutter, special flexible release, and ground-glass focusing and composing screen with the  $24\times 36$  mm Contax negative size engraved on it, in box.

Codeword: *Kleup* Key number 205

**As above, but with optical focusing device** (see fig. 20) for use instead of the ground glass.

Codeword: *Kliew* 206

Cameras, if not already available:

**Contax II**, without lens

Codeword: *Kleyu* 207

**Contax III**, without lens

Codeword: *Klias* 208

(Further information regarding the Contax will gladly be sent by Zeiss Ikon to all interested parties.)

If the "Miflex" attachment is already at hand, and is to be used in conjunction with the "Contax" camera, the following adapter is required:

**Distance piece connecting "Contax" to "Miflex".**

Codeword: *Kaikr* 209

**Ground-glass screen in holder, with  $24\times 36$  mm. picture size marked, and  $30\times 40$  mm also marked.**

Codeword: *Kieha* 210

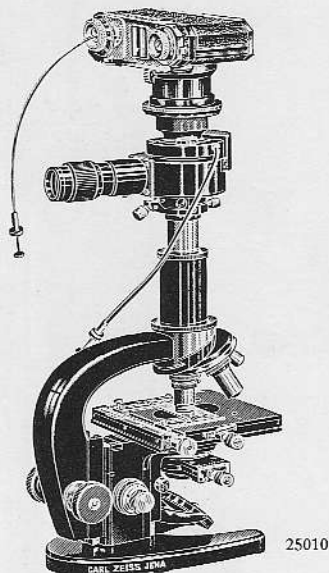

Fig. 20, about  $\frac{1}{6}$  actual size

## Projection Attachment

for demonstration purposes. The attachment is placed on the eyepiece of the microscope, and the projected image can be viewed simultaneously by a small circle of students. The attachment can be fitted to any microscope with normal eyepiece flange diameter.

Projection attachment in box (fig. 21)

Codeword: *Kiliu*

211

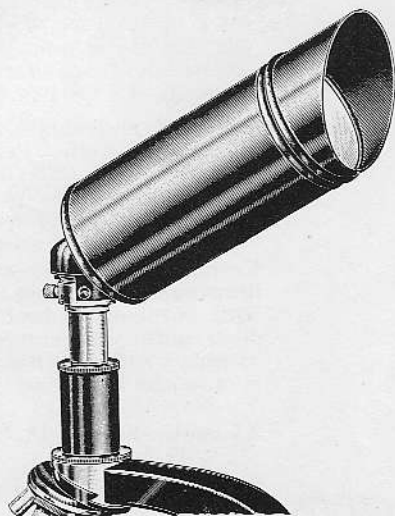
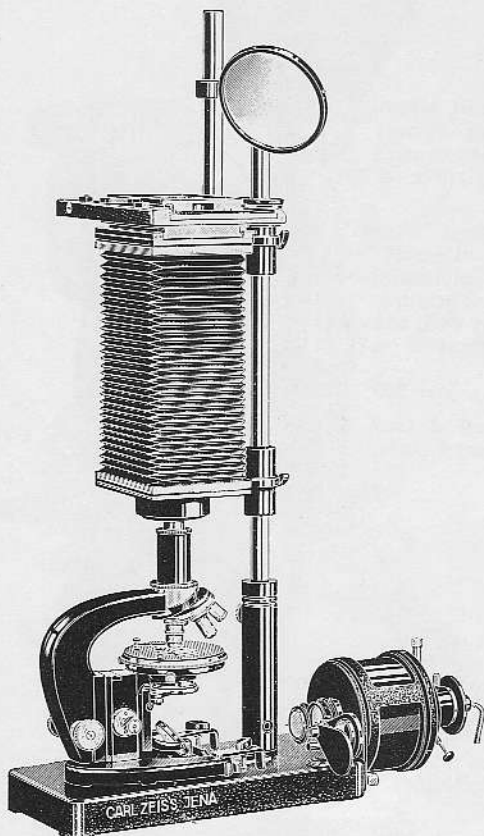

Fig. 21, about  $\frac{1}{10}$  actual size

23232



## "Standard" Vertical Camera

Fig. 22

about  $\frac{1}{8}$  actual size

14506

Simplicity and rapidity in adjustment, flexibility in range, and high efficiency in the most varied fields of photo-micrography and survey photography are the chief features of this instrument. By detaching the camera from the microscope, the user has the opportunity of using every microscope type suitable for photographic work, and to increase his range of work by the purchase of accessories.

**Vertical "Standard" camera taking  $12 \times 9$  cm. ( $4\frac{1}{4} \times 3\frac{3}{4}$ ") plates, with illuminator, consisting of:** Baseboard and pillar, variable extension camera with swing-out movements, two dark slides, one ground and one clear glass screen, illuminator comprising lamp-house and filter-holder for 33 mm.  $\varnothing$  filters, dark cover, and holder for accessory lenses, but without microscope, bulb, and electrical attachments:

Codeword: *Peuys* Key number 212

**As above, but for  $18 \times 13$  cm. ( $7 \times 5$ ") plates**

Codeword: *Pevat* 213

**Special 12 volt 8 amp projection bulb**

Codeword: *Pekru* 214



List Mikro 518 gives further details regarding this instrument



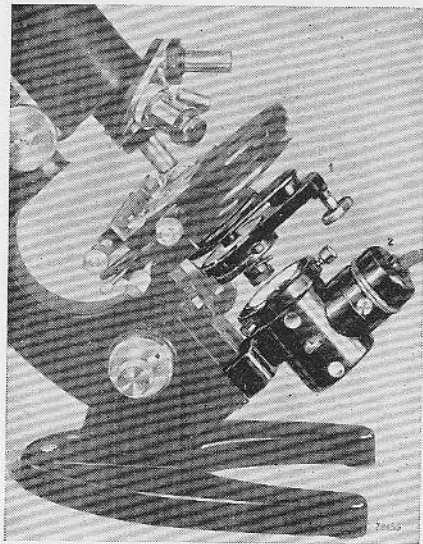

Fig. 23 a  
 1. Micropolychromar  
 2. Illuminating lamp

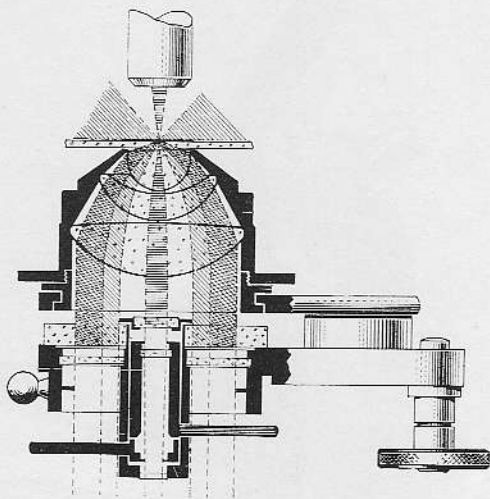

Fig. 23 b. Section through optical system  
 of micropolychromar

22741

## Micropolychromar

**Micropolychromar** for the optical coloration of microscopic objects, including 7 different colour glasses, 42 mm. diameter, of optical glass coloured throughout in bulk (and therefore fast even in the tropics), 3 colour glasses 42 mm. diameter for directional colouring and 4 smaller glasses of different colours 8.5 mm. diameter, in other case (without aplanatic condenser). . . . . Codeword: *Kakae* Key number 215 if not already available:

Aplanatic condenser N. A. 1.4 . . . . Codeword: *Micropus* 216

**Illuminating lamp**, for attaching to the microscope lamp in place of the mirror, with centring condenser with frosted glass (opaque to heat radiation), clear glass disc (heat absorbing), opal glass disc, 6 volt 8 C. P. filament lamp, lampholder and rubber covered lead with plug

Codeword: *Kakbf* 217

Same for the medium Stands V, U, E, Winkel-G, R and J

Codeword: *Kemow* 218

**Spare filament bulb** 6 volt 8 C.P. 1.15 amp. Codeword: *Kemua* 219

### Electrical Accessories:

a) for alternating current

**Transformer** Type T, 1.7 amp. for 110 and 220 volt, with connecting lead  
 Codeword: *Prodigemur* 220

**Adjustable transformer** for 110 and 220 volts, with ammeter and connecting lead . . . . . Codeword: *Mirabilior* 221

b) for direct current

**Adjustable Resistance** 1.5 amp. 320 ohms:  
 for 110 or 220 volts . . . . . Codeword: *Mincerait* 222

In ordering or in any correspondence please quote

1. the manufacturing number of the stand on which the Micropolychromar is to be used and
2. the voltage and type of the electric supply available.

For detailed description, see "Mikro 493 e"



# The new ZEISS Pancratic Condenser

A practical help for every microscope user.

The microscope, condenser, and illuminating lamp are combined in an ideal design.

Suitable for every microscope objective with apertures between 0.16 and 1.4, with a patented single adjusting control.

Fuller details in list Mikro 521

Fig. 24 shows the Pancratic condenser in approximate  $\frac{1}{2}$  its actual size

23224

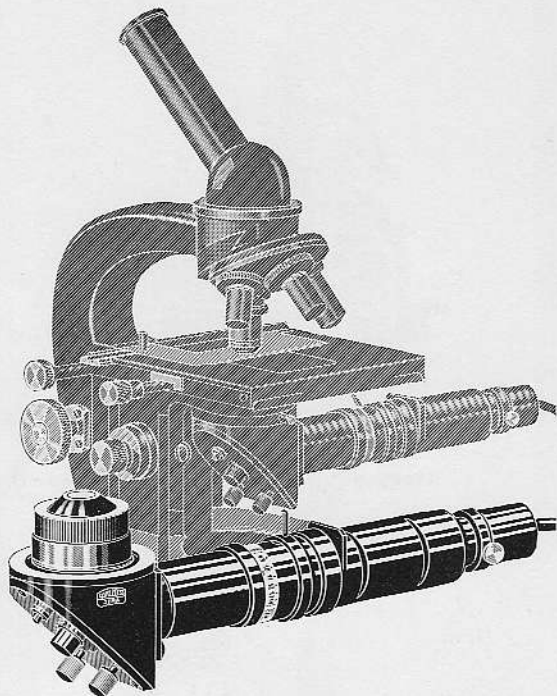

**Pancratic condenser** for transmitted light illumination when using objectives of apertures between 0.16 and 1.4, comprising pancratic system, aplanatic condenser N. A. 1.4, iris diaphragm, and filter, also central stop for dark-ground illumination, in box. Also including lampholder with cable and plug, and two frosted 8 volt 0.6 amp lamps, with centred socket.

Codeword: *Pcout* Key Number 223

## Electrical accessories:

### a) Alternating current

<b>Transformer</b> with connecting cable and mains plug:		
for 110 volt mains	Codeword: <i>Peovu</i>	224
for 220 volt mains	Codeword: <i>Peoyx</i>	225

### b) Direct current

<b>Regulating resistance</b> with connecting cable and mains plug:		
for 110 volt mains	Codeword: <i>Peozy</i>	226
for 220 volt mains	Codeword: <i>Pcpay</i>	227

<b>Spare lamps</b> , 8 volt 0.6 amp. frosted. with centred socket		
	Codeword: <i>Pepca</i>	228

## Polarization filters (Bernauer type)

New low-priced filters for polarization work

Filter polarizer (fig. 25)	Codeword: <i>Kimoz</i>	229
Filter analyser (fig. 26)	Codeword: <i>Kimpa</i>	230
<b>Compensating plates in metal holders with projecting arm:</b>		
Selenite Red I-IV . . . . .	each	231
Mica $\frac{1}{8}$ , $\frac{1}{4}$ , $\frac{3}{8}$ , $\frac{1}{2}$ , $\lambda$ . . . . .	each	232

For detailed description, see "Mikro 522"



Fig. 25 23351  
about  $\frac{2}{3}$  actual size



Fig. 26 23221 b  
about  $\frac{2}{3}$  actual size



## Quadruple eye-piece revolver

(without eyepieces) for Stands		Key number
a) Type E	Codeword: <i>Khegy</i>	233
b) Type H	Codeword: <i>Khecu</i>	234
c) Type L	Codeword: <i>Kabgu</i>	235

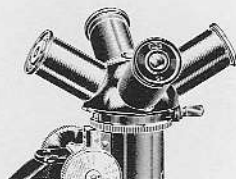

Fig. 27, about  $\frac{1}{4}$  actual size 22915

## Double Eyepiece

for simultaneous observation by two observers with one microscope. Particularly well suited for instruction purposes.

In demonstrating, it is frequently desirable to be able to point out features in the preparation. For such work, the double eyepiece should be used in conjunction with a pointer eyepiece.

Double eyepiece, in case	Codeword: <i>Mieteranno</i>	236
Huygens pointer eyepiece, 10 $\times$	Codeword: <i>Micknopf</i>	237

For detailed description, see "Mikro 360 e"

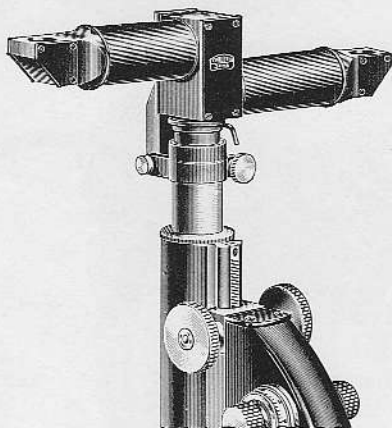

Fig. 28, about  $\frac{1}{2}$  actual size 11783

## Attachable Mechanical Stage

In microscopes having fixed or simplified mechanical stages, the use of this attachable stage affords a large degree of mobility to the preparation.

Attachable Mechanical Stage with Scale, in case	Codeword: <i>Migrateur</i>	238
Simplified Attachable Mechanical Stage without scale, in case (fig. 28)		

Codeword: *Minuebare* 239

For detailed description, see "Mikro 123 e"

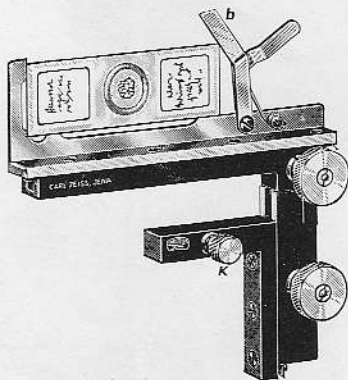

Fig. 29, about  $\frac{1}{10}$  actual size 13455

CARL ZEISS  
JENA

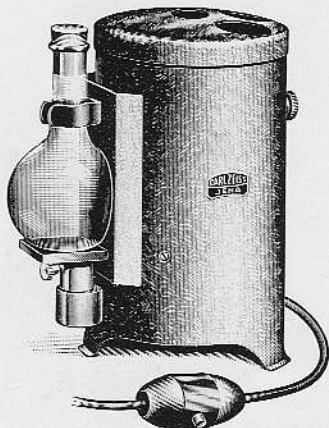

Fig. 30, about  $\frac{1}{6}$  actual size

13692

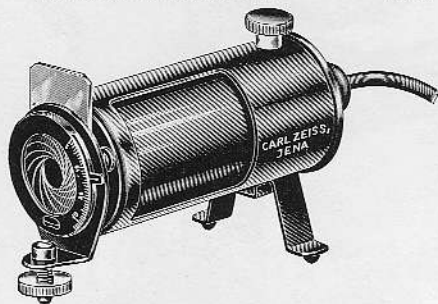

Fig. 31, about  $\frac{1}{4}$  actual size

22829

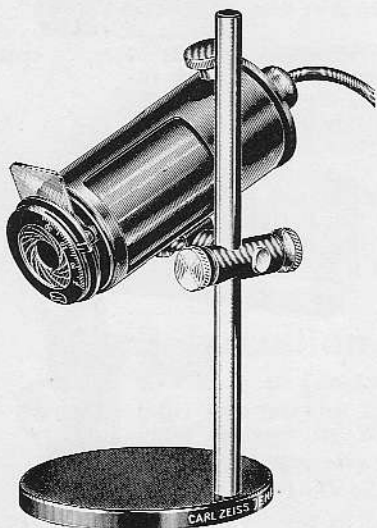

Fig. 32, about  $\frac{1}{4}$  actual size

22805

**CARL ZEISS**  
JENA

## Microscope Lamps

**Microscope Filament Lamp I** (without bulb)  
for direct connection to the mains Key number  
Codeword: *Mingi* 240

For bright field illumination, commercial bulbs of about 25 c. p. are used in conjunction with a ground glass screen. Dark ground illumination requires special dark ground bulbs.

**Dark ground bulbs, 100 watt**  
for 110 volts Codeword: *Mierla* 241  
for 220 volts Codeword: *Mierra* 242

In ordering state voltage of supply.

For detailed description, see Mikro 322 e

**Small low voltage bulbs** are of high efficiency and can be used in a compact housing. They are cheap to use when fed with alternating current through a transformer.

**Low voltage bulb housing** with aspherical illuminating lens and iris diaphragm (without bulb and lamp-holder)

**Model VI, low pattern**  
Codeword: *Kewli* 243  
also **connecting bar** for lamp VI and stand  
Codeword: *Kewso* 244

**Model VII, on pillar column adjustable and inclinable** Codeword: *Kewol* 245

For A. C. transformer with cable lamp holder and 2 bulbs

for 110 volts Codeword: *Kewyv* 246

for 220 volts Codeword: *Kexaw* 247

For D. C. resistance with cable lamp holder and 2 bulbs

for 110 volts Codeword: *Kexcy* 248

for 220 volts Codeword: *Kexea* 249

**Spare bulb 6 volts 5 amps.**  
Codeword: *Mirak* 250

For detailed description, see Mikro 485 e

We also carry Microscope Arc Lamps (see Mikro 393 e) and Microscope Spot Arc Lamps (see Mikro 410 e).

## "SPHAROLUX" High-efficiency illuminating lamp

### 100 watt lamp for direct connection to mains

For use in all types of work requiring transmitted light, including dark-ground illumination, and for photo-micrographic purposes

**Sphärolux microscope lamp** (without bulb) including condensing lens, iris diaphragm, blue filter glass and connecting cable with mains plug for direct mains connection

Key number  
Codeword: *Kisej* 251

**Connecting rail attaching lamp to microscope**

Codeword: *Kewso* 252

**100 watt projector lamps in focusing mount**

for 110 volts Codeword: *Kisin* 253

for 220 volts Codeword: *Kisjo* 254

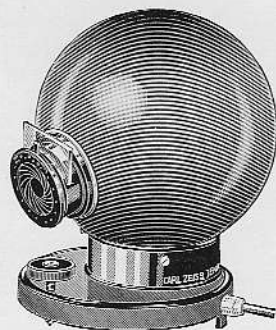

Fig. 33, about 1/5 actual size

23357

## "CIRCUM" Microscope lamp

with cable for direct mains connection

This lamp is designed for simultaneous use with a number of microscopes using bright-field illumination, and is particularly useful for classes and training courses.

The base is of metal, and contains a porcelain lamp-holder, while the clear glass dome which carries at its top a red glass cover which transmits heat rays and stops glare.

**Circum microscope lamp, without bulb**

Codeword: *Kijre* 255

For lamps, the normal 60 watt opal bulbs are recommended. The cap must be Edison screw.

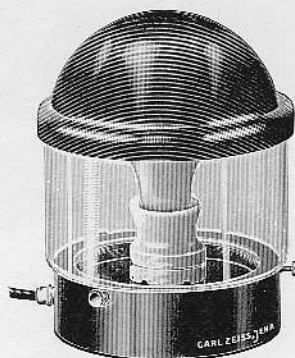

Fig. 34, about 1/5 actual size

23091

## Small Microscope lamp

for direct mains connection

A lamp suitable for use in classes where bright-field illumination is required. It is advisable to connect it to the microscope by the T-shaped guide.

**Small microscope lamp** on circular base, with ball-jointed lamp-house support, built-in switch, cable and plug, but no bulb

Codeword: *Kivsu* 256

**Osram 25 watt bulb, 110/220 volts frosted**

Codeword: *Kivvy* 257

**Blue glass filter**

Codeword: *Kiwab* 258

**T-shaped connecting guide to microscope base**

Codeword: *Kiwde* 259

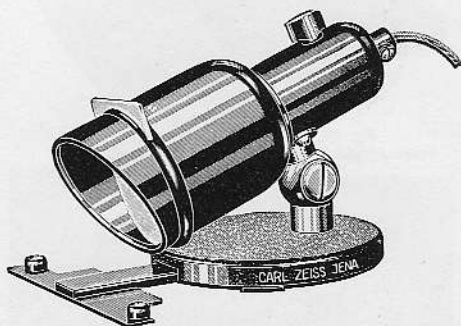

Fig. 35, about 1/4 actual size

23634



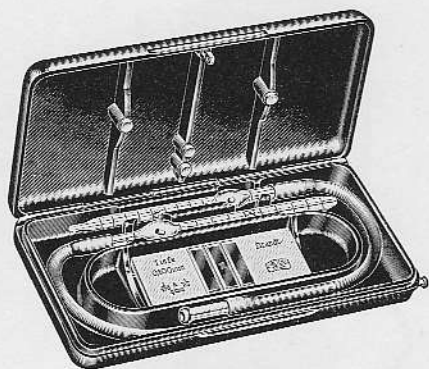

Fig. 36, about  $\frac{1}{4}$  actual size 22694  
Haemacytometer, in case

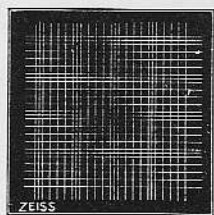

Fig. 37 8498  
about  $20\times$  actual size  
THOMA ruling

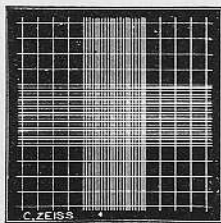

Fig. 38 8489  
about  $8\times$  actual size  
NEUBAUER ruling, with  
Thoma ruling in centre

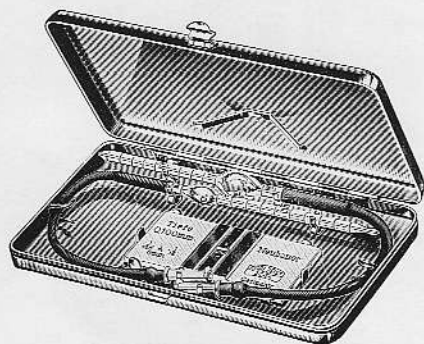

Fig. 39, about  $\frac{1}{4}$  actual size 13212  
Haemacytometer, in nickel-plated metal case

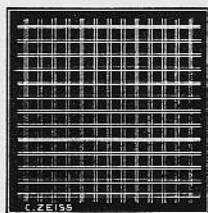

Fig. 40 11069  
about  $8\times$  actual size  
BÜRKER ruling

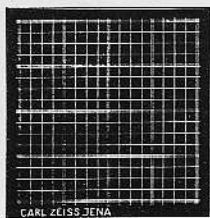

Fig. 41 13621  
about  $6\frac{1}{2}\times$  actual size  
FUCHS-ROSENTHAL ruling

## Haemacytometers

Haemacytometer with THOMA one-piece (cementless) counting chamber<sup>\*)</sup>, with two 0.4 mm. cover glasses, one 1:100 and 1:10 mixing pipette, for counting red and white blood corpuscles, in case  
Key number 260  
Codeword: *Minerala*

Ditto, with NEUBAUER counting chamber<sup>\*)</sup>  
Codeword: *Mingodin* 261

Ditto, with NEUBAUER counting chamber with double ruling  
Codeword: *Minerals* 262

Ditto, with BÜRKER counting chamber  
Codeword: *Mineralia* 263

Ditto, with BÜRKER-TÜRK counting chamber  
Codeword: *Mineralien* 264

Ditto, with BRANDT counting chamber (Fig. 30)  
Codeword: *Miraculos* 265

Ditto, with BRANDT counting chamber with quadruple ruling  
Codeword: *Miraculum* 266

Upon order, Haemacytometers will also be supplied in nickel-plated metal cases (Fig. 33)  
Additional Codeword: *Mingosmet* 267

FUCHS-ROSENTHAL Counting Apparatus for the cytological examination of the cerebrospinal fluid, with one-piece counting chamber<sup>\*)</sup> and two 0.4 mm. cover glasses, and one 1:10 mixing pipette, in leather case  
Codeword: *Mingones* 268

Similar but with JESSEN counting chamber  
Codeword: *Keuon* 269

<sup>\*)</sup> The Counting chambers are also available with spring clips  
Supplementary Codeword: *Minuito* 270

## BÜRKER Haemacytometer for counting red and white blood corpuscles

The apparatus comprises:

- 1 counting chamber with spring clips
- 1 25 cu. mm. blood pipette
- 2 transfer pipettes
- 2 large mixing flasks with stoppers<sup>1)</sup>
- 1 4975 cu. mm. diluting pipette<sup>1)</sup>
- 2 small mixing flasks with stoppers<sup>2)</sup>
- 1 475 cu. mm. diluting pipette<sup>2)</sup>
- 1 cover glass with raised centre
- 1 Francke needle for drawing blood
- 1 moist chamber

- <sup>1)</sup> for counting red blood corpuscles
- <sup>2)</sup> for counting white blood corpuscles

**Haemacytometer**, complete, with directions and forms for entering counts, in case  
Key number  
Codeword: *Mineralium* 271

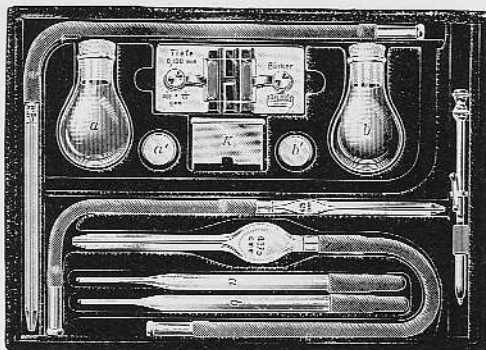

Fig. 42, about  $\frac{1}{2}$  actual size

23358

## SCHILLER Blood Smear Apparatus

for preparing blood smears by mechanical means

Codeword: *Minutero* 272

For detailed description, see "Mikro 463 e"

## PIJPER'S Blood-Cell Tester

an optical instrument for the diagnosis and control of treatment in diseases causing abnormal haemaglobin production.

**Pijper's Apparatus**, including 8 volt 3.8 amp. illuminating lamp, and lamp-holder.

Codeword: *Khami* 273

As above, but with ground-glass screen with millimetre divisions.

Codeword: *Kiwop* 274

**Spare 8 volt, 3.8 amp. lamp,**

Codeword: *Khayu* 275

**Switch and cable**

Codeword: *Kexie* 276

**Transformer** (for alternating current mains):

for 110 volt mains, including connecting cable

Codeword: *Khaok* 277

for 220 volt mains, including connecting cable

Codeword: *Khato* 278

**Resistance for direct current:**

for 110 volt mains with connecting cable Codeword: *Khaup* 279

for 220 volt mains with connecting cable Codeword: *Khaxt* 280

Further particulars of this instrument are given in list Mikro 509.

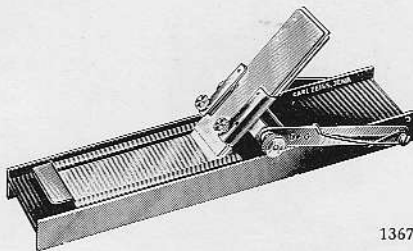

Fig. 43, about  $\frac{1}{4}$  actual size

13677

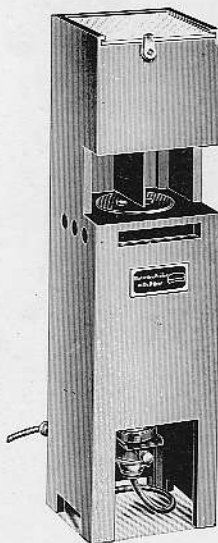

Fig. 44, about  $\frac{1}{8}$  actual size

22822

## New Zeiss Illuminating Devices for Microscopes

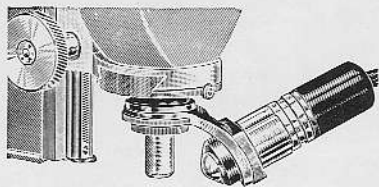

Fig. 45, about  $\frac{1}{4}$  actual size

13911

### Epi-Lamp No. 8

for observing objects of any size in unidirectional incident light. Attachment is independent of the objective. Objectives up to about 40, N. A. 0.65 may be used.

Key number

In case.

Codeword: *Kfaga*

281

### Epi-Mirror

for illuminating objects of limited size by incident light from all sides. Consists of an annular concave mirror resting on the microscope stage and receiving light through the stage opening from a special lamp set into the condenser sleeve. The object is readily accessible on a Uro glass plate which absorbs the heat radiation. Revolving azimuth diaphragm.

In case.

Codeword: *Kfays*

282

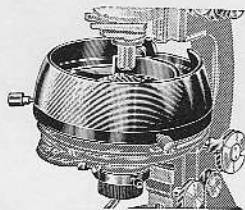

Fig. 46, about  $\frac{1}{6}$  actual size

22058

### Epi-Condenser W

for the dark field illumination, from all sides, of objects of any size. Consists of a lamp with condenser and change-over slide for bright field illumination, a housing with an annular plane mirror inclined at  $45^\circ$ , and a triple revolving nosepiece for quickly and easily changing the objectives and concave mirror condensers surrounding them.

In case.

Codeword: *Kfake*

283

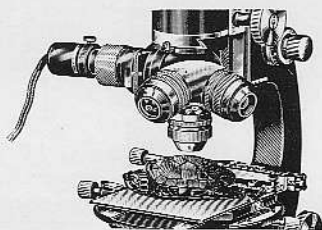

Fig. 47, about  $\frac{1}{5}$  actual size

22013

Required with above:

**3 concave mirrors**

Codeword: *Katea*

284

For detailed description, see "Mikro 476 e"



# Epi-Stands

## Models A and B

For use with Epi-Condenser W and the Epi-lamps for examining the surfaces of larger objects.

**Epi-Stand A:** Round foot plate with pillar and tube (without Epi-condenser W, adapting slide or optical equipment) in case

**Epi-Stand AA** with rack-and-pinion motion (fig. 48) Codeword: *Kheld* Key number 285

**Epi-Stand AB** with coarse motion and fine adjustment with divided drum Codeword: *Kheme* 286

### Supplementary accessories:

**Simplified mechanical stage A** with adapter Codeword: *Kheog* 287

**Ball stage** with ring adapter Codeword: *Minutione* 288

**Epi-Stand B:** Heavy round foot with pillar and adjustable cross arm with clamping pin and tube (without epi-condenser W, adapting slide or optical equipment)

**Epi-Stand BA** with rack-and-pinion motion Codeword: *Kheri* 289

**Epi-Stand BB** with coarse motion and fine adjustment with divided drum Codeword: *Kheul* 290

### Supplementary accessories:

**Compound slide** for the tube, for attaching to the arm of the stand Codeword: *Khexo* 291

For detailed description, see "Mikro 476 e"

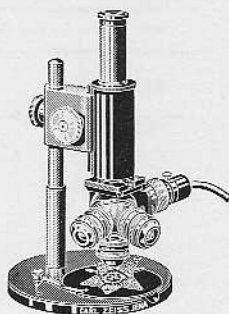

Fig. 48, about  $\frac{1}{10}$  actual size 22949 a  
Epi-Stand AA

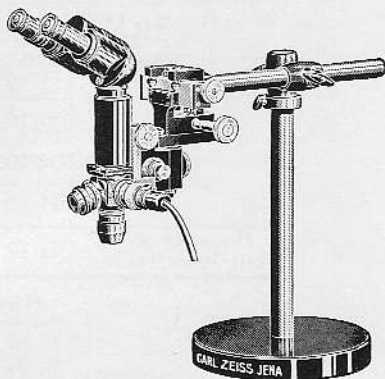

Fig. 49, about  $\frac{1}{10}$  actual size 22964  
Epi-Stand BB



# Objectives and Eyepieces for Microscopes

Short extract from the pamphlet Mikro 367

	No.	Primary Magnification	Numerical Aperture	Focal Length mm.	Free Working Distance mm.	Codeword	Key number
<b>Achromatic Objectives</b>							
"Dry" Series	11 10 08	<b>2</b>		50	60	<i>Mingote</i>	292
	11 10 03	<b>3</b>		36	29	<i>Migaja</i>	293
	11 10 05	<b>5</b>		25	12	<i>Migajada</i>	294
	11 10 06	<b>6</b>	0.17	23.5	9	<i>Migajaron</i>	295
	11 11 08	<b>8</b>	0.20	18	9	<i>Mileon</i>	296
	11 11 10	<b>10</b>	0.30	15.6	7.5	<i>Migalha</i>	297
	11 11 20	<b>20</b>	0.40	8.3	1.6	<i>Migalhada</i>	298
	11 10 40	<b>40</b>	0.65	4.4	0.55	<i>Migalhamos</i>	299
Water Immersions	11 11 07	<b>6</b>	0.11	24.7	36	<i>Migardes</i>	300
	11 11 47	<b>40</b>	0.75	4.3	1.9	<i>Migaremos</i>	301
	11 10 91	<b>90</b>	1.18	2.0	0.07	<i>Migarrosa</i>	302
Homogeneous Oil Immersions	11 10 50	<b>50*)</b>	0.90	3.5	0.40	<i>Milesa</i>	303
	11 10 92	<b>90</b>	1.25	2.0	0.11	<i>Migaveis</i>	304
	11 10 93	<b>90*)</b> with iris diaphr.	1.25	2.0	0.16	<i>Mindinha</i>	305

<b>Fluorite Objectives</b>							
(for use with compensating eyepieces)							
"Dry" Series	11 10 48	<b>40</b>	0.85	4.4	0.32	<i>Migalhando</i>	306
	11 10 60	<b>60</b>	0.90	2.9	0.12	<i>Migalharas</i>	307
	11 10 45	<b>40</b> with corr.	0.85	4.4	0.32	<i>Migamos</i>	308
	11 10 65	<b>60</b> with corr.	0.90	2.9	0.12	<i>Migarais</i>	309
	11 10 95	<b>90</b> with corr.	0.90	2.0	0.09	<i>Migaran</i>	310
	Homogeneous Oil Immersions	11 10 99	<b>100</b>	1.30	1.8	0.10	<i>Migdal</i>

<b>Apochromatic Objectives</b>							
(for use only with compensating eyepieces)							
"Dry" Series	11 01 06	<b>6</b>	0.15	255	7.3	<i>Miniaria</i>	312
	11 01 10	<b>10</b>	0.3	16.2	5	<i>Migma</i>	313
	11 01 20	<b>20</b>	0.65	8.3	0.7	<i>Migmata</i>	314
	11 01 40	<b>40</b>	0.95	4.3	0.12	<i>Migmatis</i>	315
	11 01 60	<b>60</b>	0.95	2.9	0.07	<i>Migmatum</i>	316
	Water Immersions	11 01 70	<b>70</b>	1.25	2.5	0.11	<i>Mignard</i>
Homogeneous Oil Immersions	11 01 35	<b>35*)</b>	0.85	5	0.25	<i>Minuritor</i>	318
	11 01 62	<b>60*)</b> with iris diaphr.	1.0	2.9	0.22	<i>Mingled</i>	319
	11 01 63	<b>60</b>	1.3	2.9	0.15	<i>Mignardant</i>	320
	11 01 64	<b>60</b>	1.4	2.9	0.13	<i>Mignarder</i>	321
	11 01 93	<b>90</b>	1.3	2	0.11	<i>Mignata</i>	322
	11 01 94	<b>90</b>	1.4	2	0.05	<i>Mignella</i>	323
	11 01 99	<b>120</b>	1.3	1.5	0.08	<i>Mignellir</i>	324

\*) Special objectives for dark-field observations, may also be used for bright-field observations.



# Eyepieces

## HUYGENS and Orthoscopic Eyepieces

	HUYGENS Eyepieces (= H.)					Orthoscopic Eyepieces (with wide field of view)		
Notation and Factorial Magnification	4×	5×	7×	10×	15×	12,5×	17×	28×
Focal length in mm.	63	50	36	25	17	20	15	9
Field of view number	24	23	18	14	8	16	13	6.5
No. . . .	11 35 04	11 35 05	11 35 07	11 35 10	11 35 15	11 35 12	11 35 17	11 35 28
Codeword	<i>Migeam</i>	<i>Miglia</i>	<i>Migliare</i>	<i>Migliarina</i>	<i>Migliarol</i>	<i>Migliora</i>	<i>Migliorato</i>	<i>Migliorom</i>
Key number	325	326	327	328	329	330	331	332

## Compensating Eyepieces (= K.)

Notation and Factorial Magnification	3×	5×	7×	10×	15×	20×	30×
Focal length in mm.	83	50	36	25	17	12.5	8.4
Field of view number	23	23	18	13	11	8	5.7
No. . . .	11 31 03	11 31 05	11 31 07	11 31 10	11 31 15	11 31 20	11 31 30
Codeword	<i>Mignol</i>	<i>Mignolano</i>	<i>Mignolare</i>	<i>Mignolassi</i>	<i>Mignolato</i>	<i>Mignolia</i>	<i>Minionette</i>
Key number	333	334	335	336	337	338	339

Pairs of Eyepieces = double the price of single eyepiece

Adjustable micrometer eyepieces with micrometer having a scale of 5 mm. divided into 50 parts ( $\frac{1}{10}$  mm.).

a) for *achromatic* objectives

	Codeword	Key number
No. 11 53 11. Micrometer eyepiece H 7× . . . .	<i>Miliorum</i>	340
No. 11 53 21. Micrometer eyepiece H 10× . . . .	<i>Minutus</i>	341
No. 11 53 31. Micrometer eyepiece O 17× . . . .	<i>Militabam</i>	342

b) for *apochromatic* objectives

No. 11 53 01. Micrometer eyepiece K 7× . . . .	<i>Miliolim</i>	343
No. 11 53 10. Micrometer eyepiece K 20× . . . .	<i>Minnig</i>	344
No. 12 63 00. Stage Micrometer, 1 mm. divided into 100 parts . . . . .	<i>Micciades</i>	345

The magnification of the microscope for the prescribed tube length is given by the product of the component magnifications of the objective and eyepiece. These values are engraved on the mounts.

If an additional optical component is introduced between the objective and eyepiece such as to cause an alteration of the magnification of the image formed by the objective, the product of the component magnifications of objective and eyepiece has further to be multiplied by the adjustment factor engraved on the added component.



Established 1846

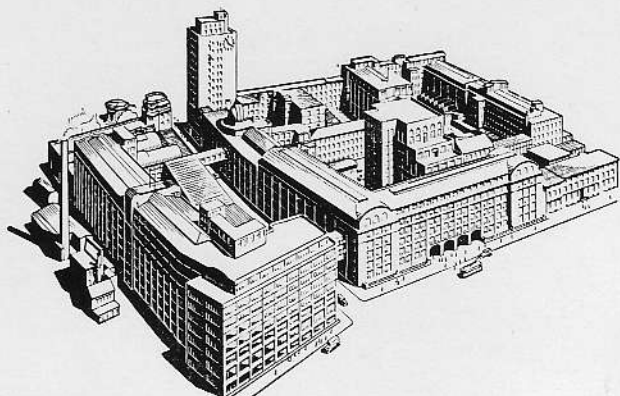

## CARL ZEISS / JENA

Telegraphic Address: **Zeisswerk Jena**

Berlin / Hamburg / Cologné / Vienna / Brussels / Buenos Aires / Rio de Janeiro / São Paulo / Tokyo

London W. 1: Carl Zeiss (London) Ltd., Mortimer House, 37-41, Mortimer Street  
New York: Carl Zeiss, Inc., 485 Fifth Avenue / Los Angeles, Cal.: Carl Zeiss, Inc., 728 So. Hill Street

Montreal, The Hughes Owens Co. Ltd., 1440 Mc Gill College Avenue, also at Ottawa, Toronto, Winnipeg / Calcutta: Adair, Dutt & Co., Ltd., Stephen House, Dalhousie Square (East) / Bombay, Embassy House, Sir Phirozshaw Mehta Road, also at Madras, Khaleel Mansions, Mount Road / Singapore: The Scientific Instrument Company Ltd., 2, Finlayson Green / Melbourne: E. C. Heyne Pty. Ltd., Union Building, 100 Flinders Street, also at Sydney / Manila: The Philippine American Drug Co. / Bangkok: B. Grimm & Co. / Cairo, Haifa, Kodak (Egypt) S. A. Johannesburg: B. Owen Jones Ltd., Commercial Exchange Building, 83, Main Street / Stockholm / Amsterdam / Paris / Milan / Madrid / Shanghai etc.

# ZEISS

## OPTICAL INSTRUMENTS

Microscopes / Photomicrographic Apparatus / Microprojection Apparatus / Ophthalmological and Endoscopic Instruments / Medical Illuminating and Radiating Appliances / Punktal Spectacle Lenses / Perivist Spectacles / Cataract Lenses / Telescopic Spectacles / Magnifiers / Photographic Objectives / Stereoscopes / Astronomical and Observation Telescopes / Optical Measuring Instruments / Field Glasses / Opera Glasses / Telescopic Sights for Sporting Rifles / Special Projector Lights / Surveying Instruments / Photogrammetric Instruments / Precision Measuring and Gauging Instruments

Catalogues will be sent free to applicants naming the instruments in which they are interested